

**Off Grid Solar Inverter  
SPF 6000T DVM-G2**

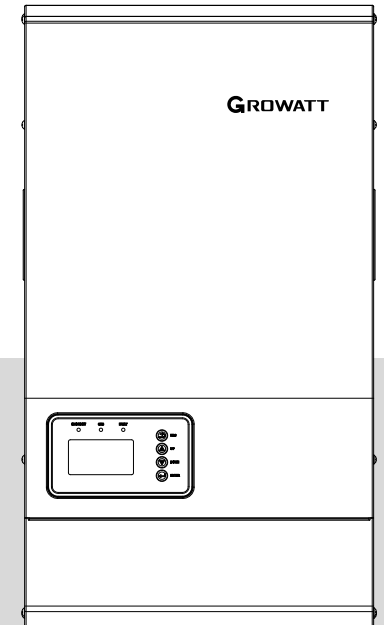

## Table Of Contents

<b>Information on this Manual</b> .....	<b>1</b>
Validity .....	1
Scope .....	1
Target Group .....	1
Safety Instructions .....	1
<b>Introduction</b> .....	<b>2</b>
Features .....	2
Product Overview .....	3
<b>Installation</b> .....	<b>4</b>
Unpacking and Inspection .....	4
Mounting the Unit .....	4
Battery Connection .....	5
AC Input/Output Connection .....	8
PV Connection .....	10
Communication Connection .....	11
Dry Contact Signal .....	11
<b>Battery Charger</b> .....	<b>12</b>
<b>Battery Equalization</b> .....	<b>13</b>
<b>Operation</b> .....	<b>14</b>
Power ON/OFF .....	14
Operation and Display Panel .....	14
LCD Display Icons .....	14
LCD setting .....	14
Display Information .....	23
Operating Mode Description .....	24
<b>Parallel Installation Guide</b> .....	<b>25</b>
Introduction .....	25
Parallel Operation in Single Phase .....	27
PV Connection .....	29
LCD Setting and Display .....	29
<b>AC Coupling</b> .....	<b>33</b>
Ac coupling .....	29
Frequency shifting .....	29
The factor 1.0 rule .....	29
Minimum battery Capacity .....	29
<b>Inverter mode+AC bypass mode jointly output</b> .....	<b>33</b>
LCD setting .....	29
Overload protection .....	29
<b>Fault Code</b> .....	<b>33</b>
<b>Warning Code</b> .....	<b>34</b>
<b>Trouble Shooting</b> .....	<b>34</b>
<b>Specifications</b> .....	<b>36</b>

## Information on this Manual

### Validity

This manual is valid for the following devices:

- ▶ SPF 6000T DVM-G2

### Scope

This manual describes the assembly, installation, operation and troubleshooting of this unit. Please read this manual carefully before installations and operations.

### Target Group

This document is intended for qualified persons and end users. Tasks that do not require any particular qualification can also be performed by end users. Qualified persons must have the following skills:

- ▶ Knowledge of how an inverter works and is operated
- ▶ Training in how to deal with the dangers and risks associated with installing and using electrical devices and installations
- ▶ Training in the installation and commissioning of electrical devices and installations
- ▶ Knowledge of the applicable standards and directives
- ▶ Knowledge of and compliance with this document and all safety information

### Safety Instructions



**WARNING: This chapter contains important safety and operating instructions. Read and keep this manual for future reference.**

1. Please be clear which kind of battery system you want, lithium battery system or lead-acid battery system, if you choose the wrong system, energy storage system can't work normally.
2. Before using the unit, read all instructions and cautionary marking on the unit, the batteries and all appropriate sections of this manual. The company has the right not to quality assurance, if not according to the instructions of this manual for installation and cause equipment damage.
3. All the operation and connection please professional electrical or mechanical engineer.
4. All the electrical installation must comply with the local electrical safety standards.
5. When install PV modules in the daytime, installer should cover the PV modules by opaque materials, otherwise it will be dangerous as high terminal voltage of modules in the sunshine.
6. CAUTION-To reduce risk of injury, charge only deep-cycle lead-acid type rechargeable batteries and lithium batteries. Other types of batteries may burst, causing personal injury and damage.
7. Do not disassemble the unit. Take it to a qualified service center when service or repair is required. Incorrect re-assembly may result in a risk of electric shock or fire.
8. To reduce risk of electric shock, disconnect all wirings before attempting any maintenance or cleaning. Turning off the unit will not reduce this risk.
9. NEVER charge a frozen battery.
10. For optimum operation of this inverter, please follow required spec to select appropriate cable size. It's very important to correctly operate this inverter.
11. Be very cautious when working with metal tools on or around batteries. A potential risk exists to drop a tool to spark or short circuit batteries or other electrical parts and could cause an explosion.
12. Please strictly follow installation procedure when you want to disconnect AC or DC terminals. Please refer to INSTALLATION section of this manual for the details.
13. GROUNDING INSTRUCTIONS -This inverter should be connected to a permanent grounded wiring system. Be sure to comply with local requirements and regulation to install this inverter.
14. NEVER cause AC output and DC input short circuited. Do NOT connect to the mains when DC input short circuits.
15. Make sure the inverter is completely assembled, before the operation.

## Introduction

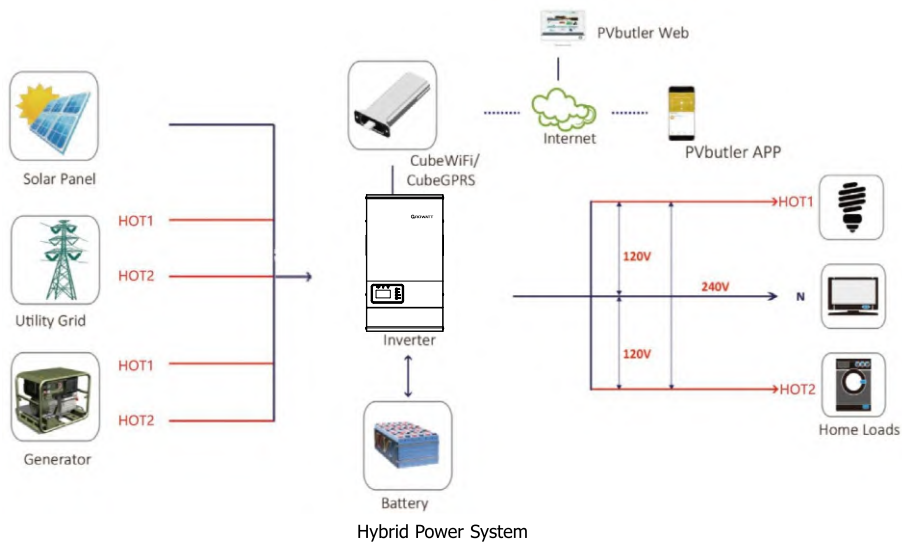

This is a multifunctional off grid solar inverter, integrated with a MPPT solar charge controller, a low frequency pure sine wave inverter and a UPS function module in one machine, which is perfect for off grid backup power and self-consumption applications. This inverter can work with or without batteries.

The whole system also need other devices to achieve complete running such as PV modules, generator, or utility grid. Please consult with your system integrator for other possible system architectures depending on your requirements. The WiFi / GPRS module is a plug-and-play monitoring device to be installed on the inverter. With this device, users can monitor the status of the PV system from the mobile phone or from the website anytime anywhere.

## Features

- ▶ Rated power 6KW, power factor 1
- ▶ PV input voltage ranges 60~250Vdc
- ▶ Low frequency inverter with large transformer
- ▶ Pure sine wave AC output
- ▶ Solar and utility grid can power loads at the same time
- ▶ With CAN/RS485 for BMS communication
- ▶ System will go to bypass and cut off charging if an error happens under utility grid mode
- ▶ With the ability to work without battery (only under utility grid mode)
- ▶ WiFi/ GPRS remote monitoring (optional)

## Product Overview

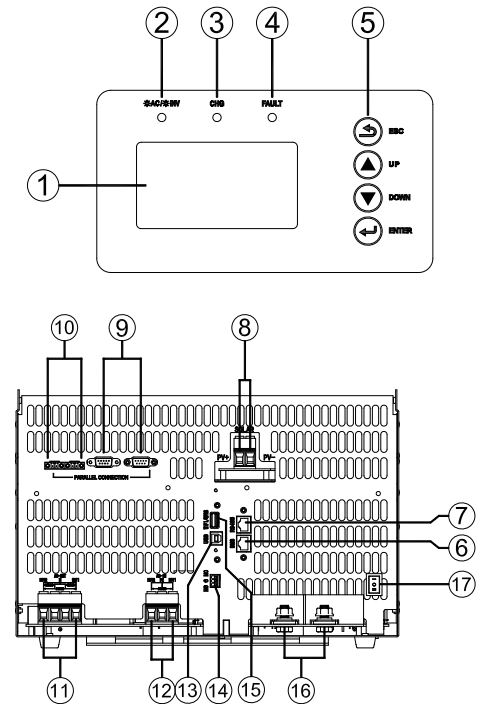
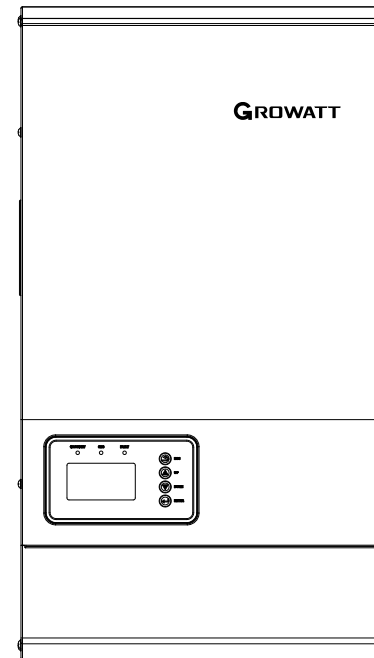

- |   |   |
|---|---|
| 1. LCD display                              | 2. Status indicator                           |
| 3. Charging indicator                       | 4. Fault indicator                            |
| 5. Function buttons                         | 6. BMS communication Port (support CAN/RS485) |
| 7. RS485 communication Port (for expansion) | 8. PV input                                   |
| 9. Current sharing ports                    | 10. Parallel communication ports              |
| 11. AC output                               | 12. AC input                                  |
| 13. USB communication port                  | 14. Dry contact                               |
| 15. WiFi/GPRS communication port            | 16. Battery input                             |
| 17. Power on/off switch                     |   |

# Installation

## Unpacking and Inspection

Before installation, please inspect the unit. Be sure that nothing inside the package is damaged. You should have received the following items in the package:

- ▶ The unit x 1
- ▶ User manual x 1
- ▶ Communication cable x 1
- ▶ Parallel communication cable x 1
- ▶ Screws x 3
- ▶ Mounting board x 1

Note: The Software CD is no longer provided, if necessary, please download it from the official website [www.ginverter.com](http://www.ginverter.com)

## Preparation

Before connecting all wiring, please take off bottom cover by removing four screws as shown below.

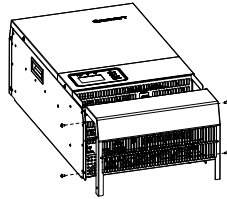

## Mounting the Unit

Consider the following points before selecting where to install:

- ▶ Do not mount the inverter on flammable construction materials.
- ▶ Mount on a solid surface
- ▶ Install this inverter at eye level in order to allow the LCD display to be read at all times.
- ▶ The ambient temperature should be between 0°C and 50°C to ensure optimal operation.
- ▶ The recommended installation position is to be adhered to the wall vertically.
- ▶ Be sure to keep other objects and surfaces as shown in the right diagram to guarantee sufficient heat dissipation and to have enough space for removing wires.

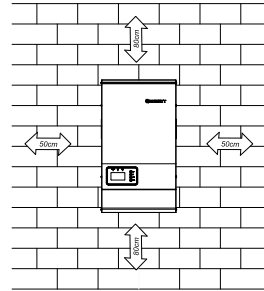

**! SUITABLE FOR MOUNTING ON CONCRETE OR OTHER NON-COMBUSTIBLE SURFACE ONLY.**

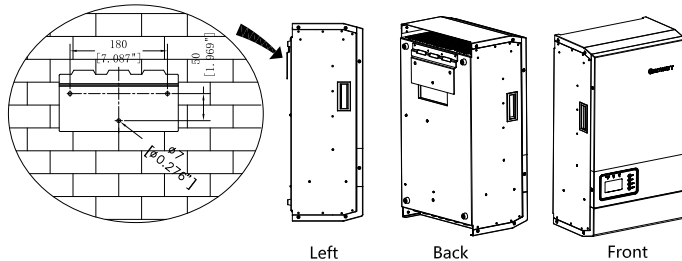

Screw three screws to install the unit. It is recommended to use attachment screw ST6.3X40 outside hexagon self-tapping stainless steel screws and Plastic expansion tube

# Battery Connection

## Lead-acid Battery Connection

User can choose proper capacity lead acid battery with a nominal voltage at 48V. Also, you need to choose battery type as "AGM(default) or FLD"

**CAUTION:** For safety operation and regulation compliance, it's requested to install a separate DC over-current protector or disconnect device between battery and inverter. It may not be requested to have a disconnect device in some applications, however, it's still requested to have over-current protection installed. Please refer to typical amperage in below table as required fuse or breaker size.

**WARNING!** All wiring must be performed by a qualified person.

**WARNING!** It's very important for system safety and efficient operation to use appropriate cable for battery connection. To reduce risk of injury, please use the proper recommended cable and terminal size as below.

**Ring terminal:**

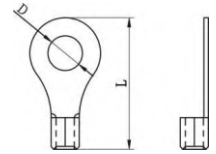

**Recommended battery cable and terminal size:**

Model	Wire Size	Torque value
SPF 6000T DVM-G2	1 * 2 AWG	2-3 Nm

**Note: For lead acid battery, the recommended charge current is 0.2C(C□battery capacity)**

Please follow below steps to implement battery connection:

1. Assemble battery ring terminal based on recommended battery cable and terminal size.
2. Connect all battery packs as units requires. It's suggested to connect at least 250Ah capacity battery for SPF 6000T DVM-G2.
3. Insert the ring terminal of battery cable flatly into battery connector of inverter and make sure the bolts are tightened with torque of 2Nm. Make sure polarity at both the battery and the inverter/charge is correctly connected and ring terminals are tightly screwed to the battery terminals.

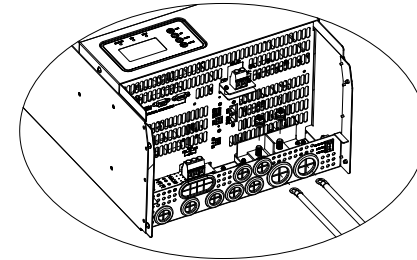

**WARNING: Shock Hazard**

Installation must be performed with care due to high battery voltage in series.



**CAUTION!!** Do not place anything between the flat part of the inverter terminal and the ring terminal. Otherwise, overheating may occur.

**CAUTION!!** Do not apply anti-oxidant substance on the terminals before terminals are connected tightly.

**CAUTION!!** Before making the final DC connection or closing DC breaker/disconnector, be sure positive (+) must be connected to positive (+) and negative (-) must be connected to negative (-).



## Lithium Battery Connection

If choosing lithium battery for the inverter, you are allowed to use the lithium battery only which we have configured. There are two connectors on the lithium battery, RJ45 port of BMS and power cable.

Please follow below steps to implement lithium battery connection:

1. Assemble battery ring terminal based on recommended battery cable and terminal size (same as Lead acid, see section Lead-acid Battery connection for details).
2. Insert the ring terminal of battery cable flatly into battery connector of inverter and make sure the bolts are tightened with torque of 2-3Nm. Make sure polarity at both the battery and the inverter/charge is correctly connected and ring terminals are tightly screwed to the battery terminals.
3. Connect the end of RJ45 of battery to BMS communication port(RS485 or CAN) of inverter.

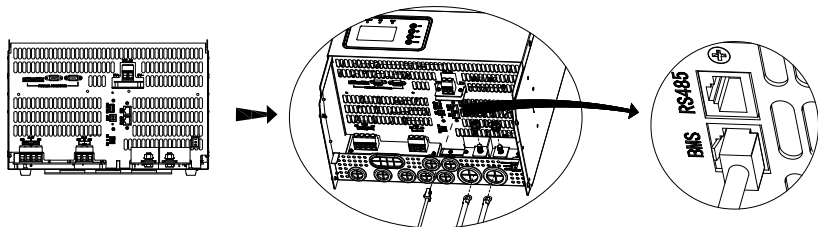

4. The other end of RJ45 insert to battery communication port(RS485 or CAN).

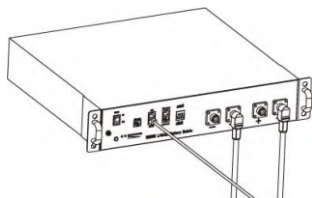

**Note:** If choosing lithium battery, make sure to connect the BMS communication cable between the battery and the inverter. You need to choose battery type as "lithium battery".

### Lithium battery communication and setting

In order to communicate with battery BMS, you should set the battery type to "LI" in Program 5. Then the LCD will switch to Program 91, which is to set the protocol type. There are several protocols in the inverter. Please get instruction from Growatt to choose which protocol to match the BMS.

#### 1. Connect the end of RJ45 of battery to BMS communication port of inverter

Make sure the lithium battery BMS port connects to the inverter is Pin to Pin, the inverter BMS port pin assignment shown as below:

Pin number	RS485 port (for expansion)	BMS port
1	RS485B	RS485B
2	RS485A	RS485A
3	--	--
4	--	CANH
5	--	CANL
6	--	--
7	--	--
8	--	--

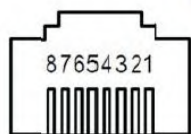

### LCD setting

To connect battery BMS, need to set the battery type as "LI" in Program 05. After set "LI" in Program 05, it will switch to Program 91 to choose communication protocol. You can choose RS485 communication protocol which is from L01 to L50, and you can also choose CAN communication protocol which is from L51 to L99.

**Note:** You can only use one communication type RS485 or CAN in a time.

05	Battery type	AGM (default)	BATT AGM 005°
		Flooded	BATT FLD 005°
		Lithium (only suitable when communicated with BMS)	BATT LI 005°
		User-Defined	BATT USE 005° If "User-Defined" is selected, battery charge voltage and low DC cut-off voltage can be set up in program 19, 20 and 21.
		User-Defined 2 (suitable when lithium battery without BMS communication)	BATT US2 005° If "User-Defined 2" is selected, battery charge voltage and low DC cut-off voltage can be set up in program 19, 20 and 21. It is recommended to set to the same voltage in program 19 and 20(full charging voltage point of lithium battery). The inverter will stop charging when the battery voltage reaches this setting.

51	RS485 Communication protocol	Protocol L01	L01 91°
		Protocol L02	L02 91°
		:	:
		:	:
		:	:
	CAN Communication protocol	Protocol L50	L50 91°
		Protocol L51	L51 91°
		Protocol L52	L52 91°
		:	:
		:	:
		Protocol L99	L99 91°

**Note:** When the battery type set to Li, the setting option 12, 13, 21 will change to display percent.

**Note:** When the battery type set as "LI", the Maximum charge current can't be modified by the user. When the communication fail, the inverter will cut off output.

12	Setting SOC point back to utility source when selecting "SBU priority" or "Solar first" in program 01	62AC 40% 012° Default 40%, 6%~50% Settable, value set higher than Program 21 setting
13	Setting SOC point back to battery mode when selecting "SBU priority" or "Solar first" in program 01	AC26 80% 013° Default 80%, 51%~100% Settable
21	Low DC cut-off SOC If "LI" is selected in program 5, this program can be set up	CUE4 20% 021° Default 20%, 5%~49% Settable, value set lower than Program 12 setting

**Note:** Any questions about communicating with BMS, please consult with Growatt.

### Communicating with battery BMS in parallel system

If need to use communicate with BMS in a parallel system, you should make sure to connect the BMS communication cable between the battery and one inverter of the parallel system. It's recommended to connect to the master inverter of the parallel system.

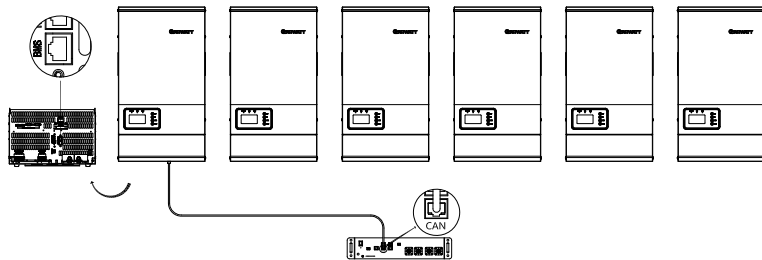

### AC Input/Output Connection

**CAUTION!!** Before connecting to AC input power source, please install a **separate** AC breaker between inverter and AC input power source. This will ensure the inverter can be securely disconnected during maintenance and fully protected from over current of AC input. The recommended spec of AC breaker is 60A for SPF 6000T DVM-G2.

**CAUTION!!** There are two terminal blocks with "IN" and "OUT" markings. Please do NOT mis-connect input and output connectors.

**WARNING!** All wiring must be performed by a qualified personnel.

**WARNING!** It's very important for system safety and efficient operation to use appropriate cable for AC input connection. To reduce risk of injury, please use the proper recommended cable size as below.

#### Suggested cable requirement for AC wires

Model	Gauge	Torque Value
SPF 6000T DVM-G2	1 * 8 AWG	1.2-1.6 Nm

Please follow below steps to implement AC input/output connection:

1. Before making AC input/output connection, be sure to open DC protector or disconnect first.
2. Cut the insulation sleeves of the six conductors by 10mm..
3. Insert AC input wires according to polarities indicated on terminal block and tighten the terminal screws. Be sure to connect PE protective conductor (⊕) first.

**PE→Ground (yellow-green)**  
**HOT2→LINE (brown or black)**  
**HOT1→LINE (brown or black)**

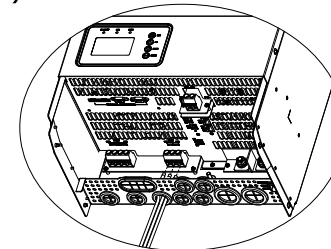

**WARNING:**  
Be sure that AC power source is disconnected before attempting to hardwire it to the unit.

4. Then, insert AC output wires according to polarities indicated on terminal block and tighten terminal screws. Be sure to connect PE protective conductor (⊕) first.

**N→Neutral (blue)**  
**HOT2→LINE (brown or black)**  
**HOT1→LINE (brown or black)**

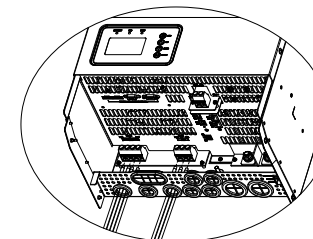

5. Make sure the wires are securely connected.

#### CAUTION: Important

Be sure to connect AC wires with correct polarity. If L and N wires are connected reversely, it may cause utility short-circuited when these inverters are worked in parallel operation.

**CAUTION:** Appliances such as air conditioner are required at least 2~3 minutes to restart because it's required to have enough time to balance refrigerant gas inside of circuits. If a power shortage occurs and recovers in a short time, it will cause damage to your connected appliances. To prevent this kind of damage, please check with

manufacturer of air conditioner that if it's equipped with time-delay function before installation. Otherwise, this off grid solar inverter will trig overload fault and cut off output to protect your appliance but sometimes it still causes internal damage to the air conditioner.

**Note:** Max. AC input current is 50A. If AC input current is over 50A, AC charge current will drop down to zero. Then the system will cut off output in 10 seconds if the AC input is continued to be over 50A.

**Note:**

- 'HOT1-HOT2' will be as the main output line (240V Max 6000W).
- 'HOT1-N' will be as the split phase output line (120V Max 3000W).
- 'HOT2-N' will be as the split phase output line (120V Max 3000W).

Output HOT1 and HOT2 can both support 120V 3000W loads at most. When HOT1 and HOT2 have both connected 1 20V loads, the LCD will only show the load percentage based on the output line which has more loads.

When output AC-OUT and either HOT1 or HOT2 have connect loads, the LCD will show the load percentage base on the sum of loads from both 2 phases.

**PV Connection**

**CAUTION:** Before connecting to PV modules, please install separately a DC circuit breaker between inverter and PV modules.

**WARNING!** All wiring must be performed by a qualified personnel. It's very important for system safety and efficient operation to use appropriate cable for PV module connection. To reduce risk of injury, please use the proper recommended cable size as below.

Model	Wire Size	Torque value
SPF 6000T DVM-G2	1 * 8AWG	1.2-1.6 Nm

**PV Module Selection:**

- When selecting proper PV modules, please be sure to consider below parameters:
1. Open circuit Voltage (Voc) of PV modules not exceeds max. PV array open circuit voltage of inverter.
  2. Open circuit Voltage (Voc) of PV modules should be higher than min. battery voltage.

<b>INVERTER MODEL</b>	SPF 6000T DVM-G2
<b>Max. PV Array Open Circuit Voltage</b>	250Vdc

Please follow below steps to implement PV module connection:

1. Remove insulation sleeve 10 mm for positive and negative conductors.

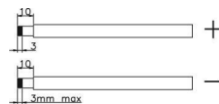

Check correct polarity of connection cable from PV modules and PV input connectors. Then, connect positive pole (+) of connection cable to positive pole (+) of PV input connector. Connect negative pole (-) of connection cable to negative pole (-) of PV input connector.

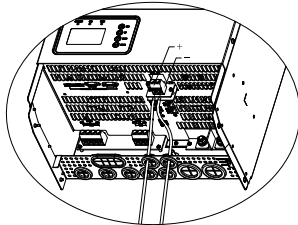

2. Make sure the wires are securely connected.

**Final Assembly**

After connecting all wiring, please put bottom cover back by screwing four screws as shown below.

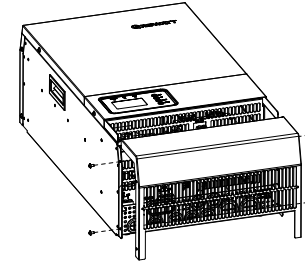

**Communication Connection**

Please use supplied communication cable to connect to inverter and PC. Insert bundled CD into a computer and follow on-screen instruction to install the monitoring software. For the detailed software operation, please check user manual of software inside of CD.

**Dry Contact Signal**

There is one dry contact(3A/250VAC) available on the rear panel. It could be used to deliver signal to external device when battery voltage reaches warning level.

Unit Status	Condition	Dry contact port: 		
		NC & C	NO & C	
Power Off	Unit is off and no output is powered.	Close	Open	
Power On	Output is off and no output is powered	Close	Open	
	Battery not in "LI" mode	Battery voltage < Low DC Cut-off Voltage +2Vdc	Open	Close
		Battery Voltage reaches setting in 13	Close	Open
	Battery in "LI" mode	Battery SOC < Low DC Cut-off Soc +5%	Open	Close
Battery Voltage reaches setting in 13		Close	Open	

# Battery Charger

The inverter is equipped with an active PFC (power factor correction) multistage battery charger.

When AC input voltage is in the range of 191~265VAC, the charging current can be adjusted based Program 2 and Program 11, which the setting range will be 0~60A. If AC input voltage is over 265VAC, the inverter will not charge by AC. when AC input goes down lower than 260v, it will recover to charge. when AC input is in the range of 155~190VAC, the maximum charge current will be 30A

There are mainly 3 stages:

**Bulk Charging:** This is the initial stage of charging. While Bulk Charging, the charger supplies the battery with controlled constant current. The charger will remain in Bulk charge until the absorption charge voltage is achieved.

**Absorb Charging:** This is the second charging stage and begins after the absorb voltage has been reached. Absorb charging provides the batteries with a constant voltage and reduces the DC charging current in order to maintain the absorb voltage setting.

In this period, the inverter will start a T1 time; the charger will keep the boost voltage in Boost CV mode until the T1 time has run out. When charging current is <0.01C or the time is over 12 hours, then drop the voltage Down to the float voltage.

**Float Charging:** The third charging stage occurs at the end of the absorb charging time. During float charging, the charge voltage is reduced to the float charge voltage. In this stage, the battery are kept fully charged and ready if needed by the inverter.

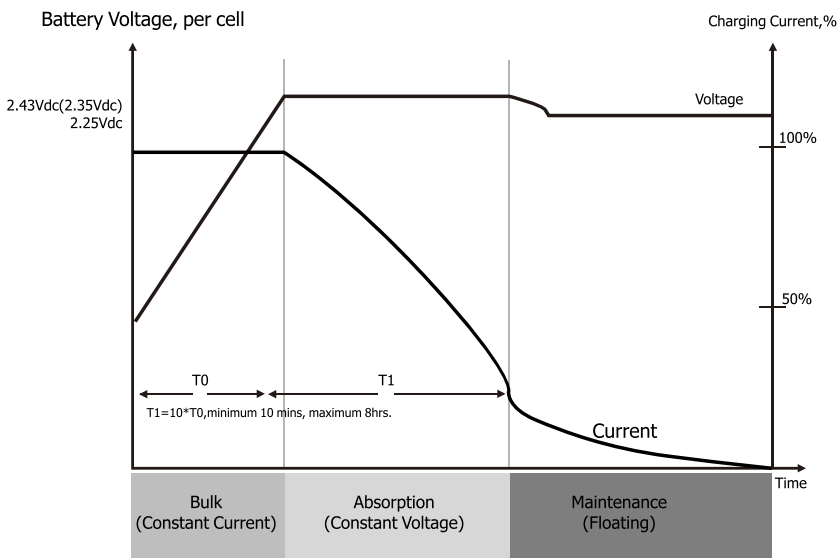

# Battery Equalization

Equalization function is added into charge controller. It reverses the buildup of negative chemical effects like stratification, a condition where acid concentration is greater at the bottom of the battery than at the top. Equalization also helps to remove sulfate crystals that might have built up on the plates. If left unchecked, this condition, called sulfation, will reduce the overall capacity of the battery. Therefore, it's recommended to equalize battery periodically.

## How to Apply Equalization Function

You must enable battery equalization function in monitoring LCD setting program 27 first. Then, you may apply this function in device by either one of following methods:

1. Setting equalization interval in program 31.
2. Active equalization immediately in program 32.

## When to Equalize

In float stage, when the setting voltage equalization interval (battery equalization cycle) is arrived, or equalization is active immediately, the controller will start to enter Equalize stage.

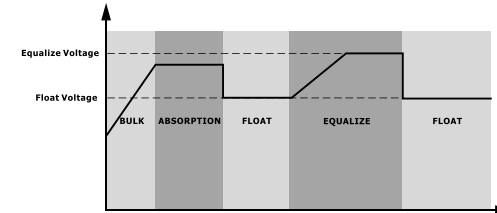

## Equalize charging time and timeout

In Equalize stage, the controller will supply power to charge battery as much as possible until battery voltage raises to battery equalization voltage. Then, constant-voltage regulation is applied to maintain battery voltage at the battery equalization voltage. The battery will remain in the Equalize stage until setting battery equalized time is arrived.

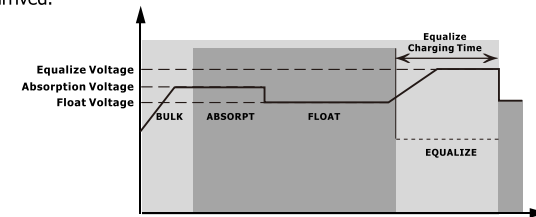

However, in Equalize stage, when battery equalized time is expired and battery voltage doesn't rise to battery equalization voltage point, the charge controller will extend the battery equalized time until battery voltage achieves battery equalization voltage. If battery voltage is still lower than battery equalization voltage when battery equalized timeout setting is over, the charge controller will stop equalization and return to float stage.

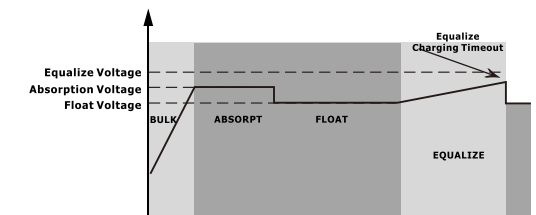

# Operation

## Power ON/OFF

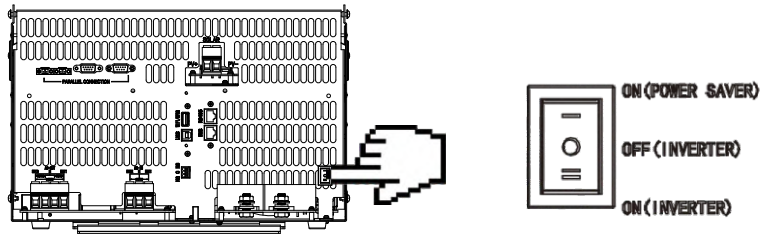

Once the unit has been properly installed and the batteries are connected well, simply press On/Off switch (located on the button of the case) to turn on the unit. The switch is located on the underside to the bottom right of the product.

The switch has three positions. The middle position means OFF. The II position means ON, turning on inverting and inverter is fully functional. The I position is Power Save Mode, inverter will only go inverting when loads are higher than 150W if under this power save mode.

## Operation and Display Panel

The operation and display panel, shown in below chart, is on the front panel of the inverter. It includes three indicators, four function keys and a LCD display, indicating the operating status and input/output power information.

1. LCD display
2. Status indicator
3. Charging indicator
4. Fault indicator
5. Function buttons

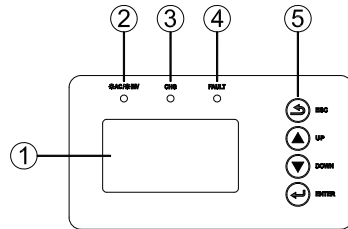

### LED Indicator

LED Indicator		Messages	
AC / INV	Green	Solid On	Output is powered by utility in Line mode.
		Flashing	Output is powered by battery or PV in battery mode.
CHG	Green	Solid On	Battery is fully charged.
		Flashing	Battery is charging.
FAULT	Red	Solid On	Fault occurs in the inverter.
		Flashing	Warning condition occurs in the inverter.

### Function Buttons

Button	Description
ESC	To exit setting mode
UP	To go to previous selection
DOWN	To go to next selection
ENTER	To confirm the selection in setting mode or enter setting mode

## LCD Display Icons

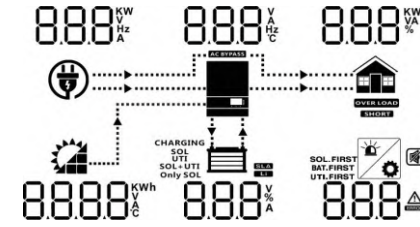

Icon	Description
<b>AC Input Information</b>	
	AC input icon
	Indicate AC input power, AC input voltage, AC input frequency, AC input current
	Indicate AC power loads in bypass
<b>PV Input Information</b>	
	PV input icon
	Indicate PV power, PV voltage, PV current
<b>Output Information</b>	
	Inverter icon
	Indicate output voltage, output current, output frequency, inverter temperature
<b>Load Information</b>	
	Load icon
	Indicate power of load, power percentage of load
	Indicate overload happened
	Indicate short circuit happened
<b>Battery Information</b>	
	Indicate battery level by 0-24%, 25-49%, 50-74% and 75-100% in battery mode and charging status in line mode.
	Indicate battery voltage, battery percentage, battery current
	Indicate SLA battery
	Indicate lithium battery
	Indicate charging source priority: solar first, solar and utility, or only solar
<b>Other Information</b>	
	Indicate output source priority: solar first, utility first, SBU mode or SUB mode
	Indicate warning code or fault code
	Indicate a warning or a fault is happening
	Indicate it's during setting values
	Indicate the alarm is disabled

In AC mode, battery icon will present Battery Charging Status		
Status	Battery voltage	LCD Display
Constant Current mode / Constant Voltage mode	<2V/cell	4 bars will flash in turns.
	2 ~ 2.083V/cell	Bottom bar will be on and the other three bars will flash in turns.
	2.083 ~ 2.167V/cell	Bottom two bars will be on and the other two bars will flash in turns.
	> 2.167 V/cell	Bottom three bars will be on and the top bar will flash.
Floating mode. Batteries are fully charged.		4 bars will be on.

In battery mode, battery icon will present Battery Capacity		
Load Percentage	Battery Voltage	LCD Display
Load >50%	< 1.717V/cell	
	1.717V/cell ~ 1.8V/cell	
	1.8 ~ 1.883V/cell	
	> 1.883 V/cell	
50%> Load > 20%	< 1.817V/cell	
	1.817V/cell ~ 1.9V/cell	
	1.9 ~ 1.983V/cell	
	> 1.983	
Load < 20%	< 1.867V/cell	
	1.867V/cell ~ 1.95V/cell	
	1.95 ~ 2.033V/cell	
	> 2.033	

## LCD Setting

After pressing and holding ENTER button for 3 seconds, the unit will enter setting mode. Press "UP" or "DOWN" button to select setting programs. Then press "ENTER" button to confirm the selection or ESC button to exit.

**Note :** When under parallel operation, only can set parameters at the HOST inverter, except for Program 23 which all inverters can be accessed to set value.

Program	Description	Setting Option
01	Output source priority: To configure load power source priority	Solar first 
		Solar energy provides power to the loads as first priority. If solar energy is not sufficient to power all connected loads, battery energy will supply power the loads at the same time. Utility provides power to the loads only when any one condition happens: Solar energy is not available Battery voltage drops to either low-level warning voltage or the setting point in program 12.
		Utility first (default) 
		Utility will provide power to the loads as first priority. Solar and battery energy will provide power to the loads only when utility power is not available.
		SBU priority 
		Solar energy provides power to the loads as first priority. If solar energy is not sufficient to power all connected loads, battery energy will supply power to the loads at the same time. Utility provides power to the loads only when battery voltage drops to either low-level warning voltage or the setting point in program 12.
02	Maximum charging current: set total charging current for solar and utility chargers. (Max. charging current = utility charging current + solar charging current)	SUB priority  Choose SUB, then press ENTER to switch to Program 90, which is set voltage point to charge battery  Default 52V, 44V~56V Settable (Program 21 < Program 90 < Program 20)
		Solar energy provides power to the loads as first priority. If solar energy is not sufficient to power all connected loads, battery energy will supply power the loads at the same time. If battery voltage drops to value set at Program 90 or lower, utility grid and solar energy will both power loads and charge battery.  Default 80A, 10A~140A Settable (If LI is selected in Program 5, this program can't be set up)



03	AC input voltage range	Appliance (default) ACV APL 003 <sup>o</sup> If selected, acceptable AC input voltage range will be within 154~272VAC
		UPS ACV UPS 003 <sup>o</sup> If selected, acceptable AC input voltage range will be within 184~272VAC
05	Battery type	AGM (default) bAtt AGM 005 <sup>o</sup>
		Flooded bAtt FLd 005 <sup>o</sup>
		Lithium (only suitable when communicated with BMS) bAtt LI 005 <sup>o</sup>
		User-Defined bAtt USE 005 <sup>o</sup> If "User-Defined" is selected, battery charge voltage and low DC cut-off voltage can be set up in program 19, 20 and 21.
		User-Defined 2 (suitable when lithium battery without BMS communication) bAtt US2 005 <sup>o</sup> If "User-Defined 2" is selected, battery charge voltage and low DC cut-off voltage can be set up in program 19, 20 and 21. It is recommended to set to the same voltage in program 19 and 20(full charging voltage point of lithium battery). The inverter will stop charging when the battery voltage reaches this setting.
06	Auto restart when overload occurs	Restart disable (default) LdRS dIS 006 <sup>o</sup>
		Restart enable LdRS ENR 006 <sup>o</sup>
		Restart bypass LdRS bYP 006 <sup>o</sup> When overload under battery mode , system will switch to bypass automatically
08	Output voltage	230V (default) 220V OUtV 230 008 <sup>o</sup> OUtV 220 008 <sup>o</sup>
		240V 208V OUtV 240 008 <sup>o</sup> OUtV 208 008 <sup>o</sup>
09	Output frequency	50Hz (default) 60Hz OUtF 50 009 <sup>o</sup> OUtF 60 009 <sup>o</sup>

11	Maximum utility charging current Note: If setting value in Program 02 is smaller than that in Program 11, the inverter will apply charging current from Program 02 for utility charger	ACI 30A 011 <sup>o</sup> Default 30A, 0A~60A Settable (If LI is selected in Program 5, this program can't be set up)
12	Setting voltage point back to utility source when selecting "SBU priority" or "Solar first" in program 01	b2AC 460V 012 <sup>o</sup> Default 46.0V, 44.0V~51.2V Settable
		b2AC 40% 012 <sup>o</sup> Default 40%, 6%~50% Settable, value set higher than Program 21 setting
13	Setting voltage point back to battery mode when selecting "SBU priority" or "Solar first" in program 01	AC2b 540V 013 <sup>o</sup> Default 54.0V, 48.0V~58.0V Settable
		AC2b 80% 013 <sup>o</sup> Lithium battery mode: default 80%, 51%~100% settable
14	Charger source priority: To configure charger source priority	If this off grid solar inverter is working in Line, Standby or Fault mode, charger source can be programmed as below:
		Utility first CGPR CUT 014 <sup>o</sup> Utility will charge battery as first priority. Solar energy will charge battery only when utility power is not available.
		Solar first CGPR CSO 014 <sup>o</sup> Solar energy will charge battery as first priority. Utility will charge battery only when solar energy is not available.
		Solar and Utility CGPR SOL-UT 014 <sup>o</sup> Solar energy and utility will both charge battery.
		Only Solar CGPR ONLY SOL 014 <sup>o</sup> Solar energy will be the only charger source no matter utility is available or not.
		If this off grid solar inverter is working in Battery mode or Power saving mode, only solar energy can charge battery. Solar energy will charge battery if it's available and sufficient.
15	Alarm control	Alarm on (default) Alarm off bUZZ ON 015 <sup>o</sup> bUZZ OFF 015 <sup>o</sup>
16	Backlight control	Backlight on (default) Backlight off LcdB ON 016 <sup>o</sup> LcdB OFF 016 <sup>o</sup>



17	Beeps while primary source is interrupted	Alarm on (default) ALARM ON 017	Alarm off ALARM OFF 017
19	C.V. charging voltage. If self-defined is selected in program 5, this program can be set up	CV 56.4V 019 Default 56.4V, 48.0V~58.4V Settable	
20	Floating charging voltage. If self-defined is selected in program 5, this program can be set up	FLEV 54.0V 020 Default 54.0V, 48.0V~58.4V Settable	
21	Low DC cut-off voltage. If self-defined is selected in program 5, this program can be set up.	CUEV 42.0V 021 Default 42.0V, 40.0V~48.0V Settable	
		CUEV 20 021 Default 20%, 5%~49% Settable, value set lower than Program 12 setting When reach Low DC cut-off voltage: If battery power is only power source available, inverter will shut down. If PV energy and battery power are available, inverter will charge battery without AC output. If PV energy, battery power and utility are all available, inverter will transfer to line mode and provide output power to loads, and charge the battery at the same time.	
22	RS485 communication address	ADDR 001 022 Default 001,001-255 Settable	
23	Parallel operation setting, parameters can be set only under battery mode (inverting mode). The system needs reboot after setting all parameters. <b>Note:</b> Parallel operation can only work when battery connected	Single: PRL 51G 023	Parallel: PRL PAL 023
		L1 Phase: PRL 3P1 023	L2 Phase: PRL 3P2 023
		L3 Phase: PRL 3P3 023	
		When the units are used in parallel with single phase, please select "PAL" in program 23.  This model can only support parallel use as single phase. The 3 phase parallel setting in the program is not effective.	
27	Battery equalization	EQUA ENA 027	EQUA DIS 027
		Battery equalization enable	Battery equalization disable(default)
		If "Flooded" or "User-Defined" is selected in program 05, this program can be set up.	

28	Battery equalization voltage	EQUV 58.4V 028 Default 58.4V, 48.0V~60V Settable (the value should be higher than Program 19 value)	
29	Battery equalized time	EQLT 060 029 Default 60min, 5min~900min Settable	
30	Battery equalized timeout	EQLT 120 030 Default 120min, 5min~900min Settable	
31	Equalization interval	EQLI 001 031 Default 1days, 1 days~90 days Settable	
32	Equalization activated immediately	Equalization activated immediately enable	Equalization activated immediately disable (default)
		EQAEN 032 EQADIS 032 If equalization function is enabled in program 27, this program can be setup. If "On" is selected in this program, it's to activate battery equalization immediately and LCD main page will shows "EQ". If "Off" is selected, it will cancel equalization function until next activated equalization time arrives based on program 31setting. At this time, "EQ" will not be shown in LCD main page.	
36	Real time setting---Year	2021 036	Default 2000, range 2000~2099
37	Real time setting---Month	10 037	Default 01, range 01~12
38	Real time setting---Date	10 038	Default 01, range 01~31
39	Real time setting---Hour	14 039	Default 00, range 00~23

40	Real time setting---Minute	11 00 52 040	Default 00, range 00~59
42	Max AC input current	6PI 30. 42	Default 30A, adjustable 5-30A
49	Utility charging time	CHG 11 7 0000 049	The time allows utility to charge the battery. Use 4 digits to represent the time period, the upper two digits represent the time when utility start to charge the battery, setting range from 00 to 23, and the lower two digits represent the time when utility end to charge the battery, setting range from 00 to 23. (eg: 2320 represents the time allows utility to charge the battery is from 23:00 to the next day 19:59, and the utility charging is prohibited outside of this period)
50	AC output time	0UP 11 7 0000 050	The time allows inverter to power the load. Use 4 digits to represent the time period, the upper two digits represent the time when inverter start to power the load, setting range from 00 to 23, and the lower two digits represent the time when inverter end to power the load, setting range from 00 to 23. (eg: 2320 represents the time allows inverter to power the load is from 23:00 to the next day 19:59, and the inverter AC output power is prohibited outside of this period)

## Display Information

The LCD display information will be switched in turns by pressing "UP" or "DOWN" key. The selectable information is switched as below order: voltage, frequency, current, power, firmware version.

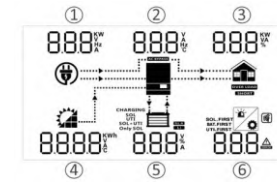

Setting Information	LCD display
① AC Input voltage ② Output voltage ③ Load percentage ④ PV input voltage ⑤ Battery voltage ⑥ Warning or Fault code (Default Display Screen)	
① AC Input frequency ② Output frequency ③ Load power in VA ④ PV energy sum in KWH ⑤ Battery percentage ⑥ Warning or Fault code	
① AC Input current ② Output current ③ Load percentage ④ PV input current ⑤ Battery charging current ⑥ Warning or Fault code	
① AC input power in Watts ② Inverter temperature ③ Load power in Watts ④ PV energy sum in KWH ⑤ Battery percentage ⑥ Warning or Fault code	
Firmware version (CPU1: 040-00-b21; CPU2:041-00-b21)	
Time (15:20:10, December 15, 2018)	

## Operating Mode Description

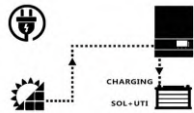
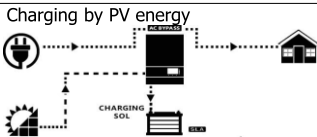
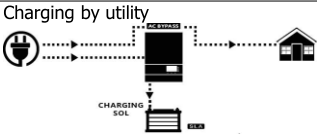
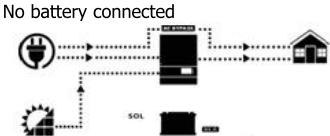
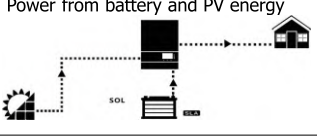
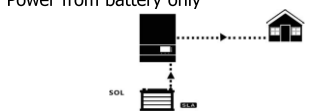
Operation mode	Description	LCD display
Standby mode <b>Note:</b> *Standby mode: The inverter is not turned on yet but at this time, the inverter can charge battery without AC output.	No output is supplied by the unit but PV it still can charge batteries.	When utility grid connected, no charging; PV can charge 
Line Mode	The unit will provide output power from the mains. It can also charge the battery at line mode.	Charging by PV energy 
		Charging by utility 
		No battery connected 
Battery Mode	The unit will provide output power from battery and PV power.	Power from battery and PV energy 
		Power from battery only 

## Parallel Installation Guide

### Introduction

This inverter can be used in parallel with one different operation modes.

Parallel operation in single phase with up to 6 units.

### Package Contents

In parallel kit, you will find the following items in the package:



Parallel communication cable

### Mounting the Unit

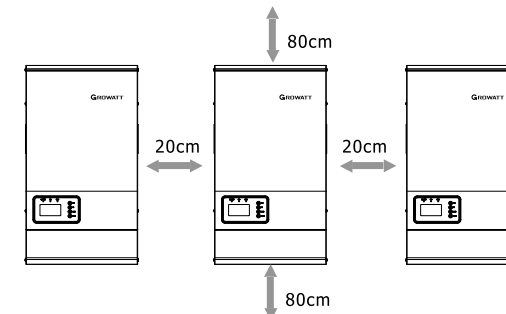

**Note:** For proper air circulation to dissipate heat, allow a clearance of approx. 20cm to the side and approx. 80 cm above and below the unit. Be sure to install each unit in the same level.

### Wiring Connection

The cable size of each inverter is shown as below

Recommended battery cable and terminal size for each inverter:

Model	Wire Size	Torque value
SPF 6000T DVM-G2	1 * 2 AWG	2-3 Nm

Ring terminal:

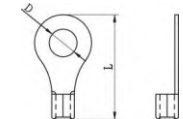

**WARNING:** Be sure the length of all battery cables is the same. Otherwise, there will be voltage difference between inverter and battery to cause parallel inverters not working.

You need to connect the cables of each inverter together. Take the battery cables for example: You need to use a connector or bus-bar as a joint to connect the battery cables together, and then connect to the battery terminal. The cable size used from joint to battery should be X times cable size in the tables above. "X" indicates the number of inverters connected in parallel.

Regarding AC input and output, please also follow the same principle.

Recommended AC input and output cable size for each inverter:

Model	Gauge	Torque Value
SPF 6000T DVM-G2	1 * 8 AWG	1.2-1.6 Nm

**CAUTION!!** Please install the breaker at the battery and AC input side. This will ensure the inverter can be securely disconnected during maintenance and fully protected from over current of battery or AC input.

Recommended breaker specification of battery for each inverter:

Model	1 unit*
SPF 6000T DVM-G2	200A / 60VDC

\*If you want to use only one breaker at the battery side for the whole system, the rating of the breaker should be X times current of 1 unit. "X" indicates the number of inverters connected in parallel.

Recommended breaker specification of AC input with single phase:

Model	2 units	3 units	4 units	5 units	6 units
SPF 6000T DVM-G2	120A/230VAC	180A/230VAC	240A/230VAC	300A/230VAC	360A/230VAC

**Note1:** You can use 60A breaker for SPF 6000T DVM-G2 for only 1 unit, and each inverter has a breaker at its AC input.

Recommended battery capacity

Inverter parallel numbers	2	3	4	5	6
Battery Capacity	500AH	750AH	1000AH	1250AH	1500AH

**WARNING!** Be sure that all inverters will share the same battery bank. Otherwise, the inverters will transfer to fault mode.

## Parallel Operation in Single Phase

**WARNING!** All inverters must be connected to the same batteries and ensure each group of cables from the inverters to the batteries in the same length.

Two inverters in parallel:

### Power Connection

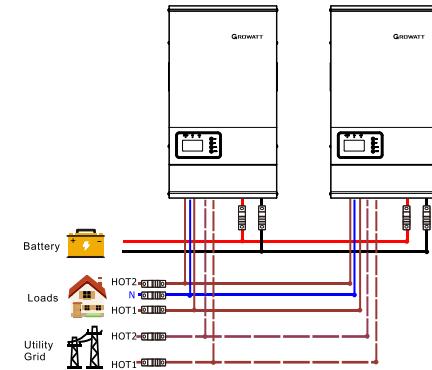

### Communication Connection

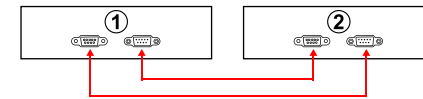

Three inverters in parallel:

### Power Connection

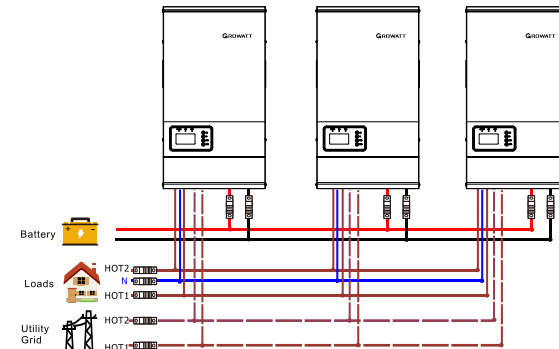

### Communication Connection

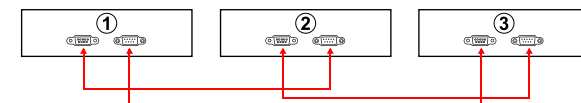

Four inverters in parallel:  
Power Connection

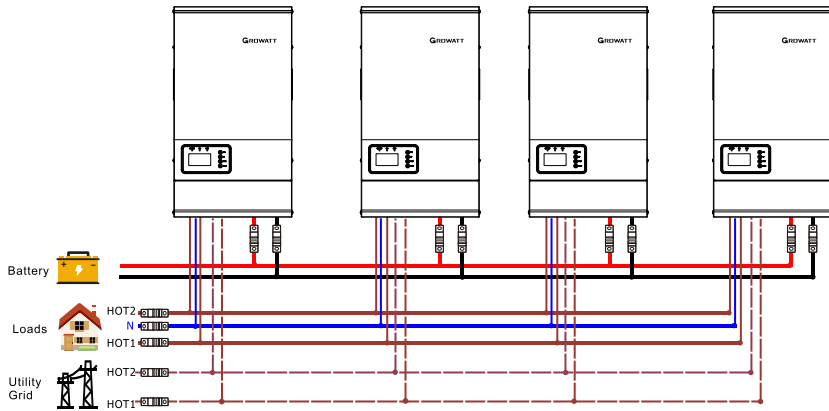

Communication Connection

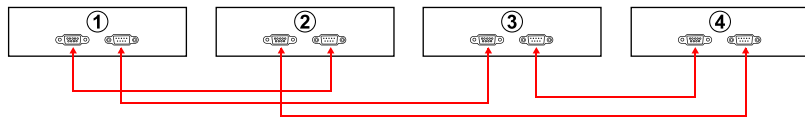

Five inverters in parallel:  
Power Connection

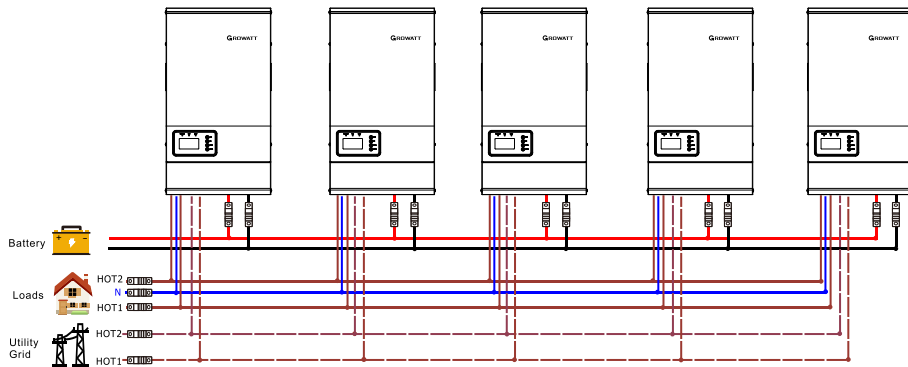

Communication Connection

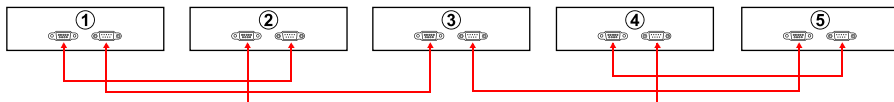

Six inverters in parallel:  
Power Connection

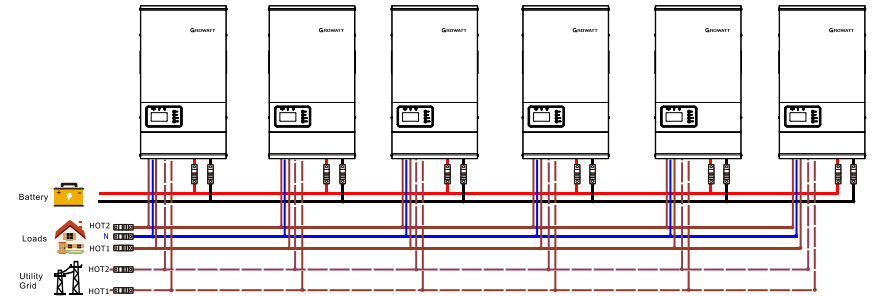

Communication Connection



**Note:** When use generator for parallel system, the inverters can only parallel use up to 3 units, otherwise could not be able to get the AC input.If the inverters parallel use over 3 units and can't get the AC input from generator, you can try add 1~2KW R type loads at the AC output.

PV Connection

Please refer to user manual of single unit for PV Connection on Page 10.

**CAUTION:** Each inverter should connect to PV modules separate.

LCD Setting and Display

Refer to Program 23 on Page 20

Parallel in Single Phase

Step 1: Check the following requirements before commissioning:

- Correct wire connection
- Ensure all breakers in Line wires of load side are open and each Neutral wires of each unit are connected together.

Step 2: Turn on each unit and set "PAL" in LCD setting program 23 of each unit. And then shut down all units.

Step 3: Turn on each unit.

Growatt SPF 6000T DVM-G2

LCD display in Master unit	LCD display in Slave unit

**Note:** Master and slave units are randomly defined.

Step 4: Switch on all AC breakers of Line wires in AC input. It's better to have all inverters connect to utility at the same time. If not, it will display warning 15.

Growatt SPF 6000T DVM-G2

LCD display in Master unit	LCD display in Slave unit

Step 5: If there is no more fault alarm, the parallel system is completely installed.

Step 6: Please switch on all breakers of Line wires in load side. This system will start to provide power to the load.

## AC-coupling

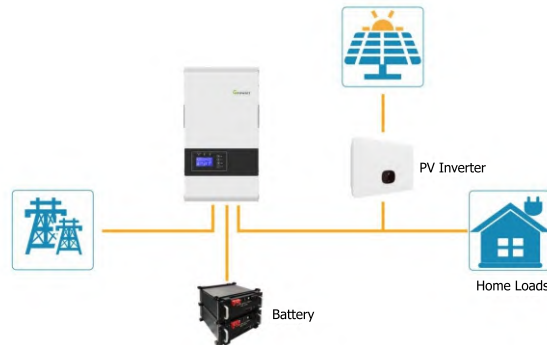

### 1.AC-coupling

In an AC-coupled system, a grid-tied PV inverter is connected to the output of SPF 6000T DVM-G2. PV power is first used to power the loads, then to charge the battery, and any excess PV power can be fed back to the grid.

When the SPF 6000T DVM-G2 is connected to the grid, this excess PV inverter power will automatically be fed back to the grid.

NOTE:The output of grid PV inverter can only be connected to the HOT1-HOT2 output of the SPF 6000T DVM-G2, but not HOT1-N and HOT2-N ,only be used in a single unit.

When the SPF 6000T DVM-G2 is operating in inverter-mode, disconnected from its AC input, it will create a local grid: a micro-grid. The PV Inverter will accept this micro-grid and will therefore operate even during a black-out. The PV power can even be used to charge the batteries: when there is more PV power available than used by the loads, the power will automatically run through the inverter in reverse direction and charge the batteries. It is necessary to regulate that power to prevent overcharging the batteries as well as overloading the inverter/charger. This is where 'frequency shifting' comes in to the picture, see next section.

Highlights:

- ( 1 ) SPF 6000T DVM-G2 can prevent feeding back PV power to grid.
- ( 2 ) Systems with only a grid-tied PV inverter will fail when there is a grid black-out. A micro-grid system will continue to operate, and even keep using solar power.
- ( 3 ) Most brands of PV inverters can be used for these systems, they need to be setup to support frequency shifting, often called the island-mode or micro-grid mode.
- ( 4 ) If power will be fed back into the grid an anti-islanding device may have to be added to the system, depending on local regulations.

## 2.frequency shifting

Frequency shifting is used to regulate the output power of a Grid-tie PV Inverter, or Grid-tie Wind inverter, by changing the frequency of the AC

## 3. The Factor 1.0 rule

The max PV power must be equal or less than the VA rating of the inverter/charger

### 3.1 Rule definition

In both grid-connected and off-grid systems with PV inverters installed on the output of SPF 6000T DVM-G2, there is a maximum of PV power that can be installed. This limit is called the factor 1.0 rule: 6.000 VA SPF 6000T DVM-G2 >= 6.000 Wp installed solar power.

### 3.2 Example and background

To understand the background, consider the following situation: the PV inverter is at full power, supplying a big load. The SPF 6000T DVM-G2 is in inverter mode. Then, suddenly and at once, this load is switched off. At that moment the PV inverter will continue operating at full power until the AC frequency has been increased. Increasing this frequency will take a very short time, but during that time all power will be directed into the batteries as there is no other place for it to go. This causes the following:

- ( 1 ) When batteries are (nearly) full, the battery voltage will spike, possibly causing the SPF 6000T DVM-G2 to switch off in DC over-voltage alarm.
- ( 2 ) The same spike will cause the AC output voltage of the SPF 6000T DVM-G2 to spike, as these two are directly related, and when the spike on the battery voltage is high and fast enough, the SPF 6000T DVM-G2 can never regulate its PWMs down fast enough to prevent the spike on AC. This spike can damage the PV inverter, the SPF 6000T DVM-G2 and also any connected loads and other equipment.
- ( 3 ) Another problem is that the SPF 6000T DVM-G2 starts charge current protection.
- ( 4 ) In the best case it might switch the grid inverter off immediately by setting the AC frequency to the disconnect frequency as configured in the assistant.

## 4.Minimum battery capacity

The minimum battery capacity depends on the type of battery, lead or lithium.

Note that, besides the minimum battery capacity, the mentioned sizes are often also the most economical battery size. In case used for self-consumption purposes that is. In case the goal is to increase autonomy, of course installing a large battery increases the system autonomy in case of a grid failure.

#### 4.1 Lead batteries

1 kWp installed PV power requires approximately 5kWh of lead acid battery:

Each additional 1 kWp of AC PV will require an additional proportional 5 kWh increase in lead acid battery storage.

#### 4.2 Lithium batteries

1,5 kWp installed AC PV power requires 4.8 kWh of battery storage:

Each additional 1.5 kWp of AC PV will require an additional proportional 4.8 kWh increase in battery storage.

### Inverter mode+AC bypass mode jointly output

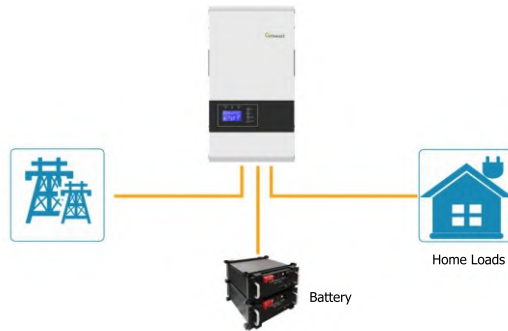

#### 1.LCD setting

1.1 please set program 01 at SUB

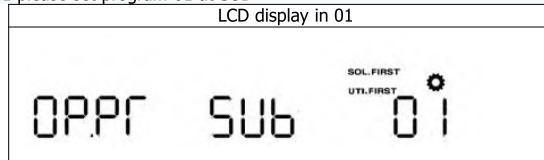

Then go into sub-program 90, set minimum voltage point for joint output (AC bypass mode+inverter mode):adjustable 44-56v

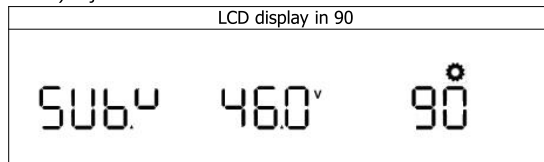

1. 2 Please set program 14 at SNU



1.3 please set program 42 at BPI, then max AC input current adjustable 5-30A settable

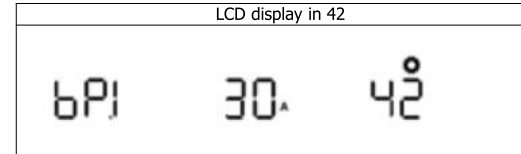

This function can only be available only when set all of above 3 steps

#### 2. Overload protection :

2.1 When load current < max AC input current +max inverter mode current, It will use Ac bypass mode and inverter mode to power connected load continuously maximum at 12kw.

When battery voltage drop to setting value at program 90, battery will not discharge in SUB mode, but only use AC input current to power connected load. inverter will say 07 overload error code if load current is bigger than max AC input current at this time.

2.2 When load current>max AC input current +max inverter mode current ,inverter says 07 overload error code after 10 seconds.

#### Fault Code

Fault Code	Fault Event	Icon on
02	Inverter Over temperature	02
03	Battery voltage is too high	03
04	Battery voltage is too low	04
05	Output short circuited	05
06	Output voltage is abnormal. Output voltage is too high.	06
07	Overload time out	07
20	BMS communication error	20
51	Over current or surge	51
56	MOS overcurrent	56
60	Negative power fault	60
80	CAN fault	80
81	Host loss	81



## Warning Code

Warning Code	Warning Event	Audible Alarm	Icon flashing
01	PV Fan is not working/ Inverter Fan is not working	Beep once every second	01 <sup>△</sup>
02	PV Over temperature	Beep once every second	02 <sup>△</sup>
04	Low battery	Beep once every second	04 <sup>△</sup>
07	Overload	Beep once every second	07 <sup>△</sup>
13	Solar charger stops due to high PV voltage	Beep once every second	13 <sup>△</sup>
14	Solar charger stops due to overload	Beep once every second	14 <sup>△</sup>
15	Parallel input utility grid different	Beep once every second	15 <sup>△</sup>
16	Parallel input phase error	Beep once every second	16 <sup>△</sup>
17	Parallel output phase loss	Beep once every second	17 <sup>△</sup>
19	Battery disconnect	Beep once every second	19 <sup>△</sup>
51	PV Over current or surge	Beep once every second	51 <sup>△</sup>
58	AC output low voltage	Beep once every second	58 <sup>△</sup>
63	Sampling error of battery voltage detecting is over 0.5V	Beep once every second	63 <sup>△</sup>

## Trouble Shooting

Problem	LCD/LED/Buzzer	Explanation / Possible cause	What to do
Unit shuts down automatically during startup process.	LCD/LEDs and buzzer will be active for 3 seconds and then complete off.	The battery voltage is too low (<1.91V/Cell)	1. Re-charge battery. 2. Replace battery.
No response after power on.	No indication.	1. The battery voltage is far too low. (<1.4V/Cell) 2. Battery polarity is connected reversed.	1. Check if batteries and the wiring are connected well. 2. Re-charge battery. 3. Replace battery.
Buzzer beeps continuously and red LED is on. (Fault code)	Warning code 01	Fan Warning	1. Check whether all fans are working properly. 2. Replace the fan.
	Fault code 02	Internal temperature of component is over 90°C.	Check if the air flow of the unit is blocked or the ambient temperature is too high.
	Buzzer beeps once every second, and red LED is flashing. (Warning code)	Fault code 03	Battery is over-charged.
The battery voltage is too high.			Check if spec and quantity of batteries are meet requirements.

Buzzer beeps continuously and red LED is on. (Fault code)	Fault code 04	The battery voltage is too low.	1. Measure battery voltage in DC input. 2. Check battery SOC in LCD when use Li battery 3. Recharge the battery.
	Fault code 05	Output short circuited.	Check if wiring is connected well and remove abnormal load.
	Fault code 06/58	Output abnormal (Inverter voltage below than 180Vac or is higher than 290Vac)	1. Reduce the connected load. 2. Return to repair center
	Fault code 07	Overload error. The inverter is overload 101% and time is up.	Reduce the connected load by switching off some equipment.
	Warning code 15	The input status is different in parallel system.	Check if AC input wires of all inverters are connected well.
	Warning code 16	Input phase is not correct.	Change the input phase S and T wiring.
	Warning code 17	The output phase not correct in parallel.	1. Make sure the parallel setting are the same system(single or parallel; 3P1,3P2,3P3). 2. Make sure all phases inverters are power on.
	Warning code 19	No battery alarm	Check that the battery is connected to the machine
	Fault code 20	BMS communication failed	1. Check the BMS communication wire to see if it's well connected 2. Check the transceiver signal
	Fault code 51	Over current or surge	Restart the unit, if the error happens again, please return to repair center.
	Fault code 56	MOS overcurrent	Restart the unit, if the error happens again, please return to repair center.
	Fault code 60	Negative power fault	1. Check whether the AC output connected to the grid input. 2. Check whether Program 8 settings are the same for all parallel inverters 3. Check whether all neutral wires of all parallel units are connected together. 5.If problem still exists, contact repair center.
	Fault code 80	CAN fault	1. Check whether the parallel communication cables are connected well.
	Fault code 81	Host loss	2. Check whether Program 23 settings are right for the parallel system. 3. If problem still exists, contact repair center

Note: To restart the inverter, all power sources need to be disconnected. After the LCD screen light is off, only use the battery to boot.

## Specifications

Table 1 Line Mode Specifications

INVERTER MODEL	SPF 6000T DVM-G2
<b>Input Voltage Waveform</b>	Pure sine wave/ same as input (bypass mode)
<b>Nominal Input Voltage</b>	240Vac
<b>Input voltage range</b>	184~272Vac ( UPS ) ; 154~272Vac ( APL )
<b>Low Loss Voltage</b>	184Vac±7V(UPS); 154Vac±7V(APL)
<b>Low Loss Return Voltage</b>	194Vac±7V(UPS); 164Vac±7V(APL)
<b>High Loss Voltage</b>	>272Vac±7V
<b>High Loss Return Voltage</b>	<262Vac±7V
<b>Nominal Input Frequency</b>	50Hz / 60Hz (Auto detection)
<b>Input Frequency range</b>	45-65Hz
<b>Low Loss Frequency</b>	45±1Hz
<b>Low Loss Return Frequency</b>	47±1Hz
<b>High Loss Frequency</b>	65 ± 1Hz
<b>High Loss Return Frequency</b>	63 ± 1Hz
<b>Efficiency (Line Mode)</b>	>95% ( Rated R load, battery full charged )
<b>Input Current</b>	Max 50A
<b>Transfer Time</b>	10ms typical, 20ms Max@ Single <30ms @ Parallel

Table 2 Inverter Mode Specifications

INVERTER MODEL	SPF 6000T DVM-G2
<b>Rated Output Power</b>	6KVA / 6KW
<b>Output Voltage Waveform</b>	Pure Sine Wave
<b>Output Voltage Regulation</b>	240Vac/120 Vac ±5%
<b>Output Frequency</b>	50Hz
<b>Peak Efficiency</b>	94%
<b>Overload Protection</b>	10s@101%~150% load; 5s@≥150% load
<b>Surge Capacity</b>	18KVA / 18KW
<b>Nominal DC Input Voltage</b>	48Vdc
<b>Cold Start Voltage(Lead-Acid Mode)</b>	Low DC Cut-Off Voltage +2Vdc
<b>Cold Start SOC(Li Mode)</b>	>Low DC Cut-off SOC +10%
<b>Low DC Warning Voltage (Lead-Acid Mode)</b>	44.0Vdc @ load < 20% 42.8Vdc @ 20% ≤ load < 50% 40.4Vdc @ load ≥ 50%
<b>Low DC Warning Return Voltage (Lead-Acid Mode)</b>	48V
<b>Low DC Cut-off Voltage (Lead-Acid Mode)</b>	42.0Vdc @ load < 20% 40.8Vdc @ 20% ≤ load < 50% 38.4Vdc @ load ≥ 50%
<b>Low DC Cut-off Voltage (Lead-Acid Mode)</b>	42.0Vdc (Based on Program 21, 40Vdc~48Vdc settable)
<b>Low DC Warning SOC (Li Mode)</b>	Low DC Cut-off SOC +5%
<b>Low DC Warning Return SOC (Li Mode)</b>	Low DC Cut-off SOC +15%
<b>Low DC Cut-off SOC(Li Mode)</b>	Default 20%, 5%~49% settable
<b>High DC Recovery Voltage</b>	58Vdc
<b>High DC Cut-off Voltage</b>	AGM:60V, FLD:62V, USE or Li Mode: C.V. Voltage + 4.0V
<b>No Load Power Consumption</b>	<35W

Table 3 Charge Mode Specifications

<b>Utility Charging Mode</b>		
<b>INVERTER MODEL</b>		<b>SPF 6000T DVM-G2</b>
<b>Charging Algorithm</b>		3-Step
<b>Max. AC Charging Current</b>		60Amp(@ $V_{I,P}=240V_{ac}$ )
<b>AC charge voltage range</b>		@191V-265V,100% Charging @155V-190V,Max. charging current 30A @>265V,no charging,recover to charge when lower to 260V
<b>Bulk Charging Voltage</b>	<b>Flooded Battery</b>	58.4Vdc
	<b>AGM / Gel Battery</b>	56.4Vdc
<b>Floating Charging Voltage</b>		54Vdc
<b>Charging Curve</b>	<p>The graph plots Battery Voltage (per cell) on the left y-axis and Charging Current (%) on the right y-axis against Time on the x-axis. The voltage curve (black) rises linearly in the Bulk stage, plateaus in the Absorption stage, and then slightly drops in the Maintenance stage. The current curve (red) is constant in the Bulk stage, drops to zero in the Absorption stage, and remains at zero in the Maintenance stage. Key voltage points are 2.43Vdc (2.35Vdc) and 2.25Vdc. Time intervals T0 and T1 are marked, with T1 being 10*10, minimum 10 mins, maximum 8hrs.</p>	
<b>MPPT Solar Charging Mode</b>		
<b>Max. PV Array Power</b>		4500W
<b>Max. PV Array Open Circuit Voltage</b>		250Vdc
<b>Max. PV Charging Current</b>		80A
<b>Bulk Charging Voltage</b>	<b>Flooded Battery</b>	58.4Vdc
	<b>AGM / Gel Battery</b>	56.4Vdc
<b>Floating Charging Voltage</b>		54Vdc

Table 4 General Specifications

<b>INVERTER MODEL</b>	<b>SPF 6000T DVM-G2</b>
<b>Operating Temperature Range</b>	-20°C to 50°C (fan assisted cooling)
<b>Storage temperature</b>	-40°C~ 60°C
<b>Humidity</b>	5% to 95% Relative Humidity (Non-condensing)
<b>Altitude</b>	<2000m
<b>Dimension(D*W*H), mm</b>	650 x 365 x 247
<b>Net Weight, kg</b>	38.5